

080724MAN

UK
English

EVOLUTION
AQUA
INNOVATION IN WATER



K+AdvancedFilter

INSTALLATION AND INSTRUCTION MANUAL



**PLEASE READ INSTALLATION INSTRUCTIONS
THOROUGHLY BEFORE INSTALLATION.**



IMPORTANT



- Never open the air blower ball valve with the pump running.
- Do not operate the multiport valve when the pump is running.
- Always rinse when backwashing until sight glass is clear.

CONTENTS

K+Advanced Filters	PAGE 3
Parts List	PAGE 4
Specifications & Flow Rates	PAGE 5
Dimensions	PAGE 6
How K+Advanced Filters Work	PAGE 7
Overview Of The Multiport Valve	PAGE 8
K+Advanced Filter Installation Examples	PAGE 9
Installing The K+Advanced Filter	PAGE 11
Setting Up The MPV & Air Blower Pipework	PAGE 12
Setting Up The MPV & Air Blower Pipework (1½")	PAGE 13
Setting Up The MPV & Air Blower Pipework (2")	PAGE 17
Setting Up The Air Blower	PAGE 21
Commissioning The K+Advanced Filter	PAGE 22
Cleaning Instructions	PAGE 23
Full Backwash And Rinse Cleaning Instructions	PAGE 24
How To Get The Best From Your K+Advanced Filter	PAGE 25
Opening / Closing The Lid	PAGE 26
Trouble Shooting	PAGE 27
Guarantee	PAGE 28

K+ADVANCED FILTERS

K+Advanced Filters, manufactured by Evolution Aqua in the UK, are a range of pressure filters that have been **specifically designed** to use Evolution Aqua's own filtration media, **K+Media**. These filters **deliver exceptional water clarity** and are **economical to run**. They are **simple to install** and can be used as a **standalone filter** or as part of a **larger filtration system** with a **Nexus+** or on a **skimmer line**. The **K+Advanced Filters** are incredibly **easy to clean** and are **supplied with K+Media, pipework, air blower** and a **multiport valve**.

Improved mechanical and **biological filtration** is achieved, thanks to Evolution Aqua's **K+Media**. The benefits of using **K+Media** have been well documented since its launch in 2019, including its ability to **filter particles down to one micron**. The **design** and **profile** of the media helps to **improve flow**, its **vast protected surface area of 1,025m² per m³** maintains **stable bio-films** and its unique manufacturing process where **minerals** and **enzymes** are added during the extrusion process, ensure **K+Media matures faster** than any other type of filter media.

Evolution Aqua's filter media has also been **independently tested** to verify its performance by **IFTS (Institut de la Filtration et des Techniques Séparatives)** and **Cranfield University**. IFTS International Filter Testing Services is the international reference for solid-liquid separation. Founded in 1981, IFTS is an independently regulated, ISO 17025 accredited, laboratory and research center focusing on liquid filtration and separation science. IFTS quality management system is certified to ISO 9001:2015.

To optimise performance, there are **unique double laterals** inside the filter that help to improve flow through the bed of **K+Media**, that is supplied with every filter. This **laminar flow**, coupled with the use of **K+Media reduces back pressure** on the circulating pump ultimately making **K+Advanced Filters** one of the **most economical filters to run**.

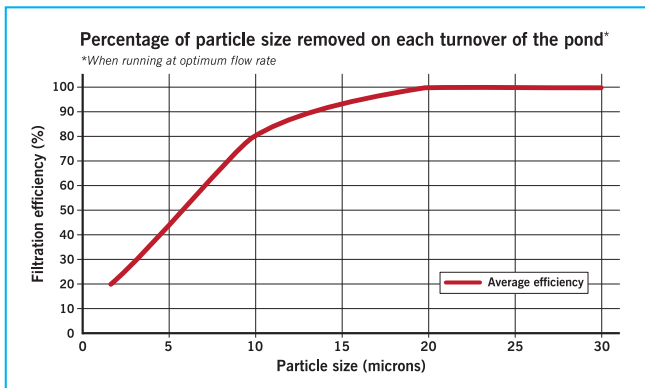

Scan QR code
to learn more



PARTS LIST

Your K+Advanced Filter comes complete with the following items.

Pipework and Fittings, Multiport Valve and Air Blower are supplied in a separate box.



1) K+Advanced Filter
Including K+Media, lid, air relief bleed valve & caps.



2) Threaded Collars & O-Rings
Pre-fitted onto filter



3) Multiport Valve
1½" MPV with 20"
2" MPV with 24", 30", 36"



4) Air Blower & Connector (K82-20-50)
(Straight connector 1.5" plain to 1.5" female thread)

FOR FILTER SET-UP YOU WILL ALSO NEED:

- Solvent weld adhesive to glue pipework
- Pipe cleaner (EA Code: S99-0-500)
- PTFE tape
- Masking tape
- Pen / Pencil
- Spirit level

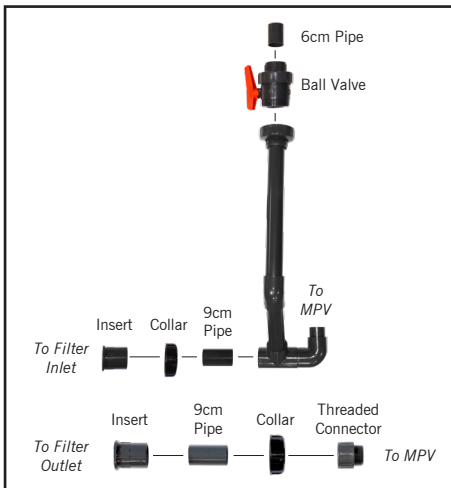

5) 1½" Pipework Fittings for MPV and Air Blower Ball Valve (20" models.)

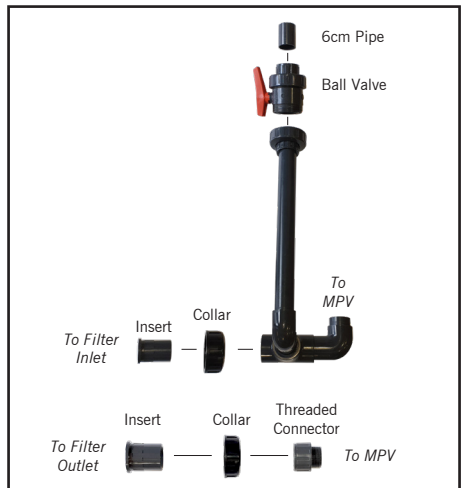

6) 2" Pipework & Fittings for MPV and Air Blower Ball Valve (24", 30", 36" models.)

SPECIFICATIONS

	K+ADVANCED FILTER 20	K+ADVANCED FILTER 24	K+ADVANCED FILTER 30	K+ADVANCED FILTER 36
Diameter	20" (500mm)	24" (620mm)	30" (750mm)	36" (900mm)
Quantity of K+Media included	50 Litres 11 Gallons 13.2 US Gallons	100 Litres 22 Gallons 26.4 US Gallons	150 Litres 33 Gallons 39.6 US Gallons	250 Litres 55 Gallons 66 US Gallons
Maximum pond size	4,000 UK Gallons 18,000 Litres 4,800 US Gallons	8,000 UK Gallons 36,000 Litres 9,600 US Gallons	12,000 UK Gallons 54,000 Litres 14,500 US Gallons	20,000 UK Gallons 90,000 Litres 24,000 US Gallons
Optimum flow rate	6,000 Lph 1,320 Gph 1,585 US Gph	12,000 Lph 2,640 Gph 3,170 US Gph	18,000 Lph 3,960 Gph 4,755 US Gph	30,000 Lph 6,600 Gph 7,925 US Gph
Maximum working pressure	1.5 Bar	1.5 Bar	1.5 Bar	1.5 Bar
Multiport valve	1½"	2"	2"	2"
Air blower	✓	✓	✓	✓

FLOW RATES

To allow the **K+Advanced Filter** to give the best performance, it is important that the optimum flow rates are used.

Open cell media such as **K+Media** has been extensively tested at **IFTS**. This has allowed us to optimise the ideal flow rate, scientifically, through the **K+Advanced Filter**.

K+Advanced Filters are capable of flow rates over and above the optimum flow rate but the working pressure within the unit **SHOULD NOT EXCEED 1.5 BAR**.

DIMENSIONS

K+ADVANCED FILTER 20

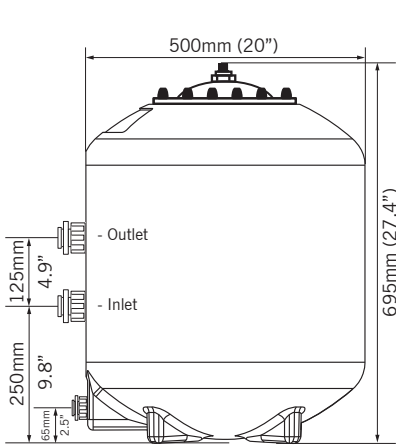

K+ADVANCED FILTER 24

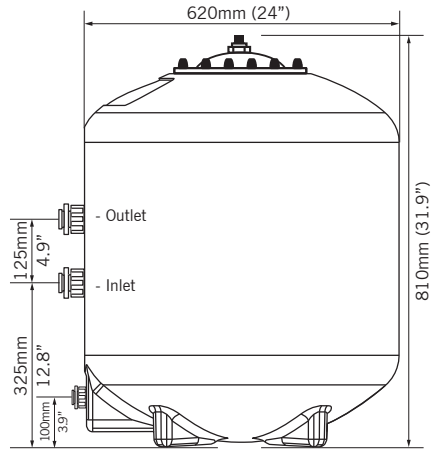

K+ADVANCED FILTER 30

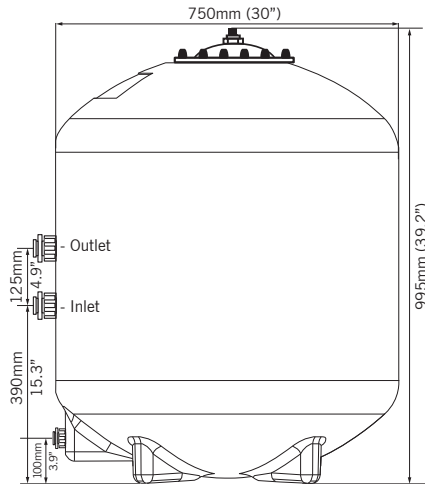

K+ADVANCED FILTER 36

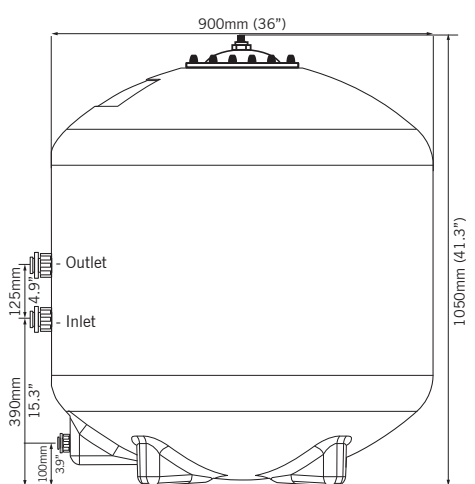

When installing the K+Advanced Filter in low head room spaces be aware that when the blower is attached the overall height will be greater than shown.

HOW K+ADVANCED FILTERS WORK

Water enters the filter from the pond into the multiport valve (MPV) and is directed to the bottom of the unit. As the water is pumped through the **K+Advanced Filter**, dirt, debris and waste are trapped by the **K+Media** and then the massive protected surface area housing the filter bacteria and breaks down biologically the Ammonia and Nitrite into Nitrate. The filtered water is returned to the top of the unit through the multiport valve and back to the return line flowing back into the pond.

The laterals have been specifically designed to give optimum flow through the **K+Media**. The **K+Advanced Filter** is optimised to be less restrictive than many other similar filters. Because of this the **K+Advanced Filter** maintains its flow rate between cleaning cycles.

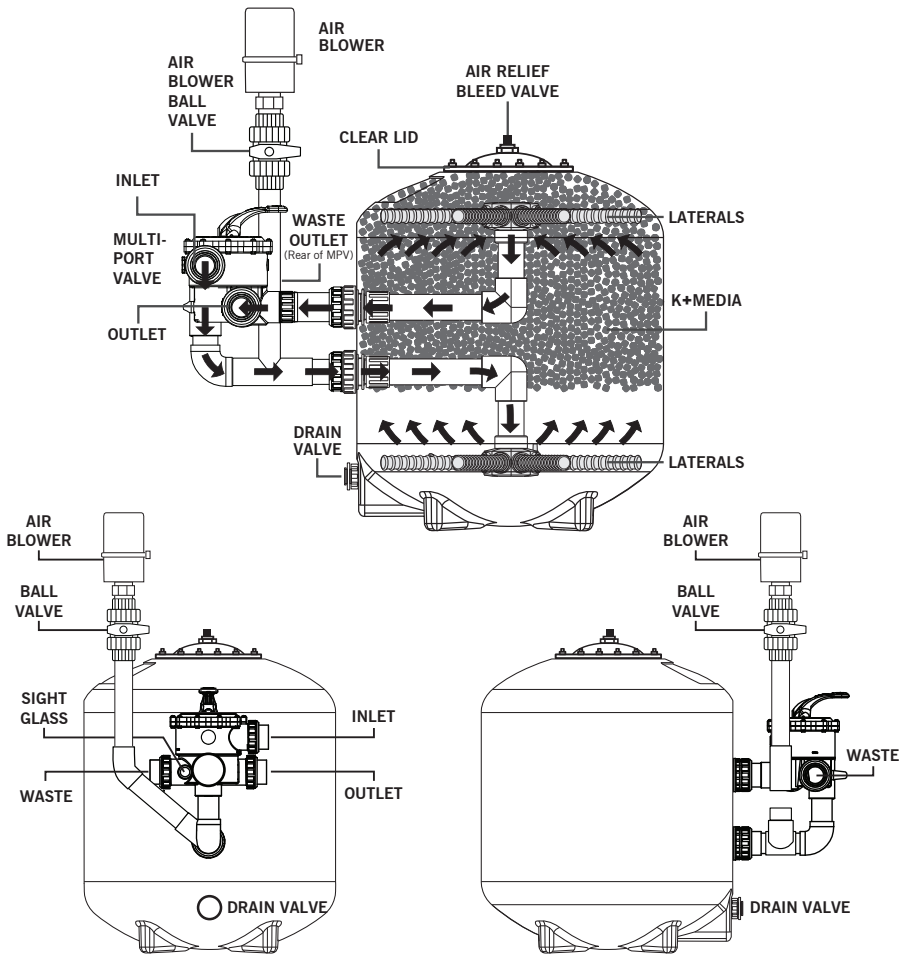

OVERVIEW OF THE MULTIPOINT VALVE



IMPORTANT: Do not operate the multiport valve when the pump is running.

The K+Advanced Filter is operated by the multiport valve. This multiport valve functions by pushing down on the handle, turning it and relocating it into one of the operating positions shown on the multiport valve. **The valve must be operated with the circulating pump switched OFF. The ball valve positioned below the air blower must be closed when the pump is running.** Below we offer an explanation of each of the multiport valve's functions:

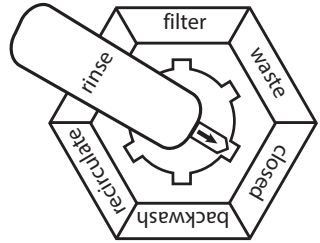

1) FILTER: Incoming water from the pond enters the MPV at point (A). The water enters the vessel at point (D) then flows upwards through the K+Media filter media to the top exit bar (B). The filtered water is returned through the multiport valve at point (C) and back into the pond.

2) BACKWASH: This is the position the multiport valve should be in for cleaning the K+Media. With the valve in this position, water flow is reversed through the filter bed so that the water flow is directed to the top of the unit (B) and exits the unit at (D) and goes out to the waste line (E).

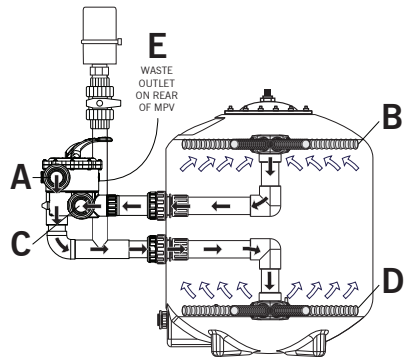

3) RINSE: This is the position the multiport valve should be in for agitating the K+Media. With the valve in this position, air (supplied by the air blower) is used to agitate the filter media. Later on in the cleaning process, water is used to rinse the K+Media and exit to waste (E).

4) WASTE: This is the position the multiport valve should be in to allow water to by-pass the filter bed and drain to waste (E). With the multiport valve in this position, the water flow is directed straight to waste by-passing the unit. This function can be used to lower the water level or for vacuuming your pond without soiling the filter.

5) RE-CIRCULATE: This is the position the multiport valve should be in to allow water to completely by-pass the filter. With the valve in this position, water is pumped from the pond to the multiport valve and directly back to the pond, without flowing through the K+Advanced Filter. This is particularly handy if you are treating your pond.

6) CLOSED: This is the position the multiport valve should be in for closing all flow to the filter. This position is not to be used with the pump running.

K+ADVANCED FILTER INSTALLATION EXAMPLES

The K+Advanced Filter is a versatile unit. It can be installed on pump-fed or gravity fed set-ups. It can be used as a stand alone filter, in conjunction with a pre-filter, it can be used on skimmer lines or as a polisher at the end of a system.



IMPORTANT: Never open the air blower ball valve with the pump running.



IMPORTANT: Do not operate the multiport valve when the pump is running.



IMPORTANT: Air blower must always be above the water level of the pond.

TYPICAL INSTALLATION WITH A CETUS SIEVE

We highly recommend installing a pre-filter when using the K+Advanced Filter as the sole filtration on your pond. This will prevent leaves, string algae blocking your filtration system.

We also recommend installing an appropriately sized evoUV on the return line to the pond.

On 24", 30" and 36" K+Advanced Filters it is recommended that 2" pipe is used on the pump side (from the pump to the filter and back to the pond). On 20" K+Advanced Filters it is recommended that 1½" pipe is used.

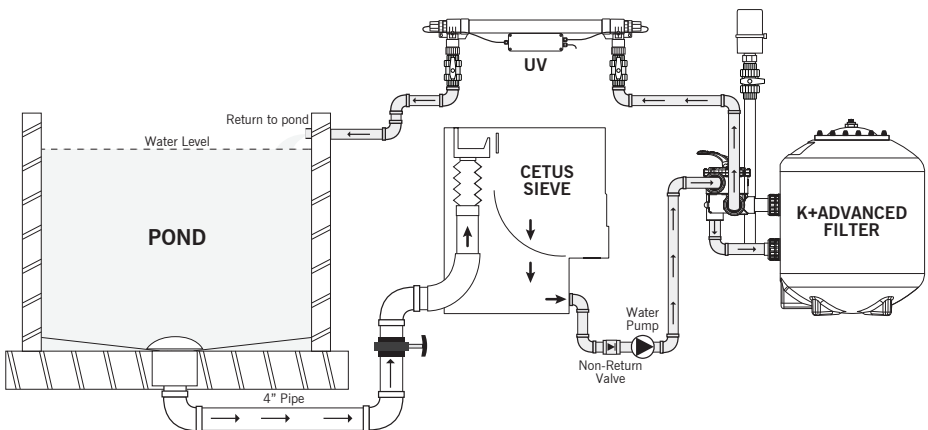

K+ADVANCED FILTER INSTALLATION EXAMPLES



IMPORTANT: Never open the air blower ball valve with the pump running.



IMPORTANT: Do not operate the multiport valve when the pump is running.



IMPORTANT: Air blower must always be above the water level of the pond.

TYPICAL INSTALLATION ON A SKIMMER LINE

The diagram below shows a K+Advanced Filter installed on a skimmer line.

On 24", 30" and 36" K+Advanced Filters it is recommended that 2" pipe is used on the pump side (from the pump to the filter and back to the pond). On 20" K+Advanced Filters it is recommended that 1½" pipe is used.

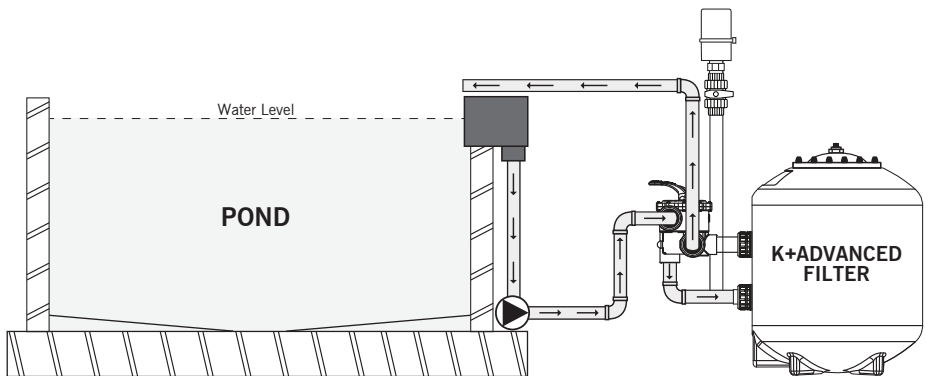

INSTALLING THE K+ADVANCED FILTER



IMPORTANT: Air blower must always be above the water level of the pond.



Always assemble and **“dry fit”** any pipework and fittings first before gluing.

LOCATION

The filter **MUST** be installed on a flat, level base, on firm ground or equivalent. Ensure the ground will not subside and strain pipework. We recommend using a flat solid concrete surface as a base large enough for the filter to sit on.

Ideally, position the filter as close as possible to the pond.

The filter should be in a location that is free from flooding, is away from sumps, guttering, garden hollows and areas that may experience sub-zero conditions etc.

DO NOT position the filter in an area where the air blower is exposed to water ingress.

The air blower must always be above the water level of the pond.

Allow room around the K+Advanced Filter to enable easy maintenance and servicing.

PIPE CONNECTIONS

On 24”, 30” and 36” K+Advanced Filters it is recommended that 2” pipe is used on the pump side (from the pump to the filter and back to the pond). On 20” K+Advanced Filters it is recommended that 1½” pipe is used.

A non-return valve **MUST BE** installed on the pumps suction line, prior to the pump. Alternatively a ball valve or slide valve can be used.

Refer to your pump manufacturer’s manual to see if the pump is self-priming. For the avoidance of doubt install your pump below the pond water level.

Prepare your pipework so it is ready to connect up to the multiport valve. The pump line (inlet), return line and waste lines are marked on the valve. We advise fitting your pipework dry to check it before using solvent weld adhesive to glue it.

Allow a full 24 hours for all glued pipework joints to harden.

SETTING UP THE MPV & AIR BLOWER PIPEWORK



Always assemble and **“dry fit”** any pipework and fittings first before gluing. Particularly to ensure the multiport valve and blower are lined up correctly.



It is advisable to move your K+Advanced Filter into its desired location before gluing any pipework to avoid any issues.

GOOD PRACTICE

It is always good practice to **“dry fit”** all the pipework and fittings first before gluing. This allows you to check the components are lined up correctly. This is important as it allows you to ensure the blower pipe is vertical, the multiport valve is level and aligned square to the filter, and the connecting pipework is set to the correct lengths.

Once the **“dry fit”** is complete, before you dis-assemble the pipe and fittings, it is good practice to apply masking tape to the pipe and fittings where they join. Then draw lines with a pen or pencil that connect across both lengths of masking tape. When you come to re-assemble and glue the components you know exactly how to re-align them.



“Dry fit” pipework first



Check blower is vertical



Draw lines with a pen

When you need to glue pipework components we always advise you clean the pipe first using a cloth and **PIPE CLEANER (EA CODE: S99-0-500)**. Then use **SOLVENT WELD ADHESIVE** to glue the pipe and fittings. Apply solvent weld adhesive to both the pipe and connectors you are gluing together to ensure all surfaces are covered and a complete seal is formed. Please note solvent weld adhesive cures quickly.



Clean pipe first



Apply glue to inside and...



...outside of joining parts

SETTING UP THE MPV & AIR BLOWER PIPEWORK (1½")

Open the pipework accessories box to find all the pipework components, blower and multiport valve.



Always assemble and **“dry fit”** your pipework and fittings first before gluing to ensure all the components, multiport and blower are lined up correctly.

1½" PIPEWORK AND FITTINGS SUPPLIED WITH 20" MODELS

Note there are 2 x 9cm lengths of pipe for the inlet and outlet. The 1 x 6cm pipe is for the blower.

The air relief bleed valve must be screwed into the centre of the lid. This may have been supplied taped to the lid for protection during transit.



SETTING UP THE MPV & AIR BLOWER PIPEWORK (1½")



Always assemble and **“dry fit”** your pipework and fittings first before gluing to ensure all the components, multiport and blower are lined up correctly.



Unscrew collar from filter outlet.



Unscrew collar from filter inlet.



Take note that there is an O-Ring located inside the thread. Ensure this does not move during assembly.



Take one of the inserts and fit one of the collars over the insert.



Screw the collar onto the outlet. **HAND TIGHTEN ONLY.**



Take note that there is an O-Ring located inside the thread. Ensure this does not move during assembly.



Take the other insert and fit the collar over the insert.



Screw the collar onto the inlet. **HAND TIGHTEN ONLY.**



Take the threaded connector for the MPV. Wrap PTFE tape clockwise around the thread multiple times to ensure a water tight connection.

SETTING UP THE MPV & AIR BLOWER PIPEWORK (1½")



Always assemble and **“dry fit”** your pipework and fittings first before gluing to ensure all the components, multiport and blower are lined up correctly.



Screw the threaded connector into the multiport valve.



Push in one of the 9cm pipes into the threaded connector. **YOU WILL GLUE THIS CONNECTION LATER.**



Push in the other 9cm pipe into the t-piece on the pipework assembly. **YOU WILL GLUE THIS CONNECTION LATER.**



Now take the blower pipework and push the multiport valve outlet onto the upright. **YOU WILL GLUE THIS CONNECTION LATER.**



Fit this assembly into the filter inserts until you hit a positive stop. **YOU WILL GLUE THESE CONNECTIONS LATER.**



Ensure the multiport valve is horizontal.



Use a spirit level to check the blower pipe is vertical.



Apply two pieces of masking tape flush to the points where the multiport valve outlet and the connecting pipe join.



Draw three vertical lines across the two pieces of masking tape. When you glue this later ensure these lines match up.

SETTING UP THE MPV & AIR BLOWER PIPEWORK (1½")



Always assemble and **“dry fit”** your pipework and fittings first before gluing to ensure all the components, multiport and blower are lined up correctly.



Remove the assembly.



Clean and glue inside the MPV connector and the outside of the 9cm pipe and push together.

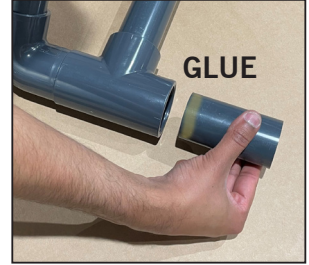

Clean and glue inside the t-piece and outside the 9cm pipe and push together.



Clean and glue inside the MPV outlet and around the outside of the connector pipe on the elbow and push together. Ensure the lines on the masking tape match up.

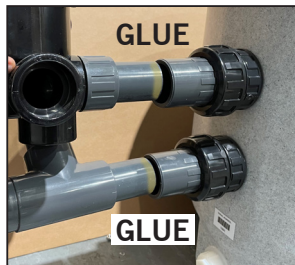

Clean and glue the outside of the inlet and outlet inserts and inside the connectors. Push assembly into the inserts until you hit a positive stop.



Allow the glue to set. The filter should now look like this.



If the blower ball valve is not connected, screw the union onto the ball valve. **HAND TIGHTEN ONLY.**



Take the 6cm pipe insert. At one end, clean and glue the outside of the pipe and the inside of the ball valve and push together.



Screw the blower union onto the blower. **HAND TIGHTEN ONLY.** Then clean and glue the outside of the pipe and the inside of the blower union and push together.

SETTING UP THE MPV & AIR BLOWER PIPEWORK (2")

Open the pipework accessories box to find all the pipework components, blower and multiport valve.



Always assemble and **“dry fit”** your pipework and fittings first before gluing to ensure all the components, multiport and blower are lined up correctly.

2" PIPEWORK AND FITTINGS SUPPLIED WITH 24" / 30" / 36" MODELS

The air relief bleed valve must be screwed into the centre of the lid. This may have been supplied taped to the lid for protection during transit.

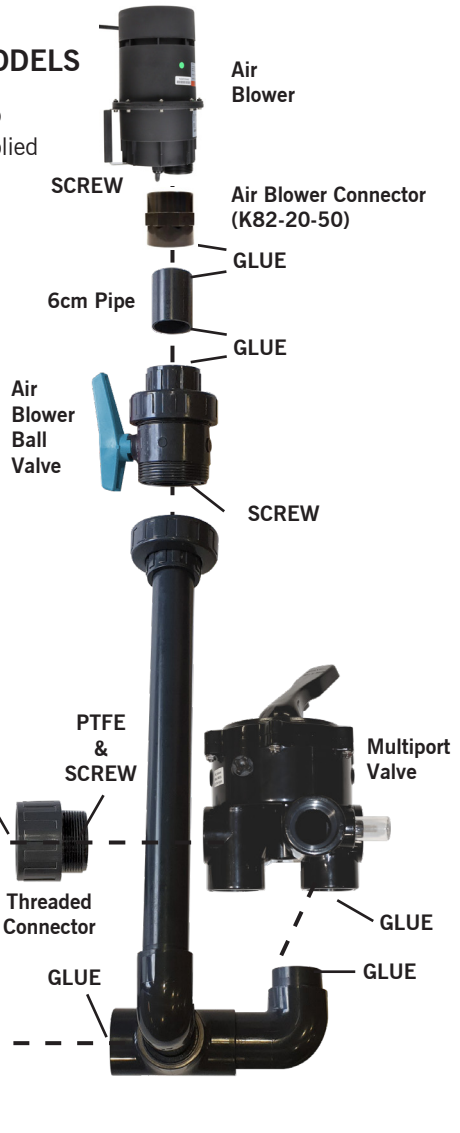

SETTING UP THE MPV & AIR BLOWER PIPEWORK (2")



Always assemble and **“dry fit”** your pipework and fittings first before gluing to ensure all the components, multiport and blower are lined up correctly.



Unscrew collar from filter outlet.



Unscrew collar from filter inlet.



Take note that there is an O-Ring located inside the thread. Ensure this does not move during assembly.



Take one of the inserts and fit one of the collars over the insert.



Screw the collar onto the outlet. **HAND TIGHTEN ONLY.**



Take note that there is an O-Ring located inside the thread. Ensure this does not move during assembly.



Take the other insert and fit the collar over the insert.



Screw the collar onto the inlet. **HAND TIGHTEN ONLY.**



Take the threaded connector for the MPV. Wrap PTFE tape clockwise around the thread multiple times to ensure a water tight connection.

SETTING UP THE MPV & AIR BLOWER PIPEWORK



Always assemble and **“dry fit”** your pipework and fittings first before gluing to ensure all the components, multiport and blower are lined up correctly.



Screw the threaded connector into the multiport valve.

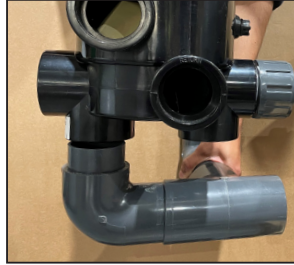

Now take the blower pipework and push the multiport valve outlet onto the upright. **YOU WILL GLUE THIS CONNECTION LATER.**



Fit this assembly onto the filter inserts. **YOU WILL GLUE THESE CONNECTIONS LATER.**



Use a spirit level to check the blower pipe is vertical.



Ensure the multiport valve is horizontal. Mark the bottom pipe if needed so you now how far to push the pipe when you glue it later.



Apply two pieces of masking tape flush to the points where the multiport valve outlet and the connecting pipe join.



Draw three vertical lines across the two pieces of masking tape. When you glue this later ensure these lines match up.



Your “dry fit” assembly will look like this.



Remove the assembly.

SETTING UP THE MPV & AIR BLOWER PIPEWORK



Read the cleaning and gluing advice shown on page 12 before gluing.

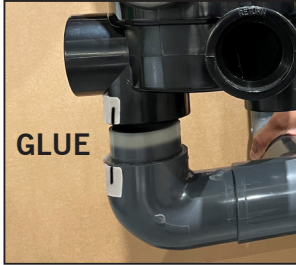

Clean and glue inside the MPV outlet and around the outside of the connector pipe on the elbow and push together. Ensure the lines on the masking tape match up.

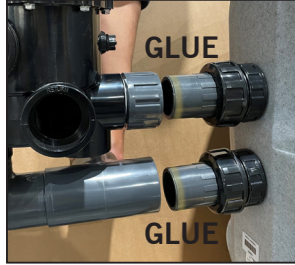

Clean and glue the outside of the inlet and outlet inserts and inside the connectors. Push assembly onto the inserts - matching up to the mark you made earlier if needed.



Allow the glue to set. The filter should now look like this.



If the blower ball valve is not connected, screw the union onto the ball valve. **HAND TIGHTEN ONLY.**



Take the 6cm pipe insert. At one end, clean and glue the outside of the pipe and the inside of the ball valve and push together.



Screw the blower union onto the blower. **HAND TIGHTEN ONLY.**



Clean and glue the outside of the pipe and the inside of the blower union and push together.

SETTING UP THE AIR BLOWER

Your K+Advanced Filter comes with an air blower that is used during cleaning cycles.



IMPORTANT: Air blower must always be above the water level of the pond.



IMPORTANT: Never open the air blower ball valve with the pump running.



IMPORTANT: We recommend electrical installations are carried out by a qualified electrician.

The air blower can be wired directly into a switch box with an RCD fitted. Please note, there is no plug supplied with the air blower.

The power supply must meet the specifications on the product (see ratings label). The cores in the supply cable are coloured in accordance with the following code:

UK / EU:

Brown = Live

Blue = Neutral

Green / Yellow = Earth (IF FITTED)

Do not use the supply cable to lift the air blower as this may cause damage.



IMPORTANT

The ball valve handle must always be closed when the circulating pump is switched on. This is designed to prevent water flowing back into the air blower.

The ball valve handle in a horizontal position indicates that the ball valve is **CLOSED**.

The ball valve handle in a vertical position indicates that the ball valve is **OPEN**.

**FAILURE TO FOLLOW THESE INSTRUCTIONS
MAY INVALIDATE THE WARRANTY.**

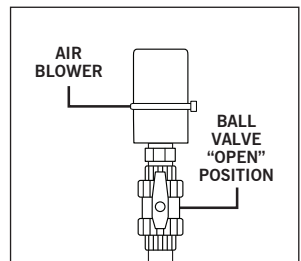
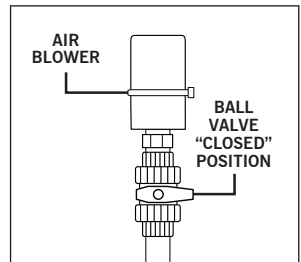

COMMISSIONING THE K+ADVANCED FILTER

We recommend adding Evolution Aqua's **PURE+FILTERSTARTGel** to the filter media inside the K+Advanced Filter, to help mature the media faster. Follow the procedure on page 26 to unscrew the lid and empty the contents of the bottle onto the filter media.

Ensure the lid is re-fitted correctly and nuts fastened in the correct sequence and to the correct torque settings.

Ensure the air relief bleed valve is screwed into the centre of the lid. This may have been taped to the lid for protection during transit.

Carry out a visual check around the filter and pipework to double check all the fittings are hand tight / glued correctly.

Double check all the nuts on top of the clear lid are all tight and the cover caps are fitted.

Check the air blower ball valve is in the closed position and it is switched off.

Once you are happy, set the multiport valve to the FILTER position.

You are ready to run to turn your circulation pump on and run your filter.

Keep checking your set up for any leaks that may appear on your pipework. Use PTFE tape on threads.

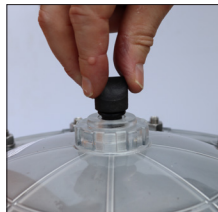

PURE+ FILTERSTARTGel

Live Bacteria Gel To Start New Pond Filters

PURE+ Filter Start Gel is a **live, concentrated bacteria culture** for use in **new pond filters**.

The gel based solution will **stick to the filter media**, allowing the nitrifying bacteria it contains to **rapidly colonise your filter**.

Once the filter media has been coated with the **PURE+** Filter Start Gel, the beneficial bacteria within the gel will **speed up the maturation** of your filter media, while helping to **convert ammonia and nitrite**, resulting in **less stressed fish**.

Available in 2 sizes:

1 litre treats ponds up to 10,000 litres

2.5 litre treats ponds up to 25,000 litres

Available from Evolution Aqua stockists

CLEANING INSTRUCTIONS



IMPORTANT: Never open the air blower ball valve with the pump running.



IMPORTANT: Do not operate the multiport valve when the pump is running.

The function of rinsing and backwashing is to separate the deposited particles of waste from the filter media and to flush these particles to waste.

On the initial start up of the filter it is sound advice to let the filter run for a full 2 weeks before you perform the first rinse and backwash to help mature the filter media.

The K+Advanced Filter can be cleaned quickly and effectively using the RINSE cycle. This can be carried out as necessary for your pond, but we would recommend at least once every 7 days.

For a more thorough clean, follow the full BACKWASH cleaning cycle (shown on next page), which takes a little more time and will use more water. We would recommend you backwash every 2 weeks.

QUICK CLEAN / RINSE INSTRUCTIONS

We recommend a QUICK CLEAN / RINSE at least once every 7 days. Repeat if necessary. See next page for full BACKWASH cleaning steps.

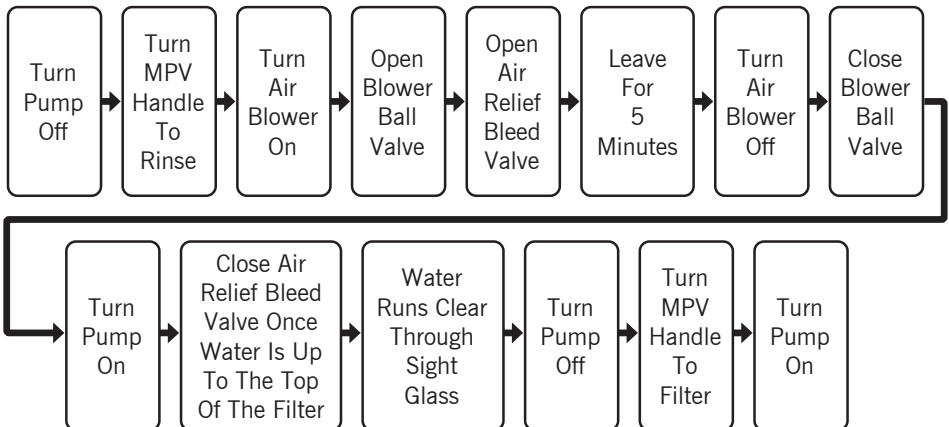

FULL BACKWASH AND RINSE CLEANING INSTRUCTIONS

We recommend a full backwash every 2 weeks. Repeat steps if necessary.

1. Switch **PUMP OFF**.
2. If installed with a bottom drain, **CLOSE THE 4" BOTTOM DRAIN BALL VALVE**.
3. Turn the multiport valve handle to the **RINSE** position.
4. Switch the **AIR BLOWER ON**.
5. **OPEN AIR BLOWER BALL VALVE** .
6. **OPEN THE AIR RELIEF BLEED VALVE** on the lid to release air from the filter.
7. **LEAVE FOR 5 MINUTES** to agitate the K+Media.
8. **CLOSE THE AIR RELIEF BLEED VALVE** on the lid.
9. Switch the **AIR BLOWER OFF**.
10. **CLOSE AIR BLOWER BALL VALVE**.
11. Turn the multiport valve handle to the **BACKWASH** position.
12. If installed with a bottom drain, **OPEN THE 4" BOTTOM DRAIN BALL VALVE**.
13. Switch the **PUMP ON**.
14. **OPEN THE AIR RELIEF BLEED VALVE**. It is important when performing the backwash that the filter is full with water to remove the waste properly. Release any trapped air by using the air relief bleed valve. This will keep the filter filled with water.
15. Once all the air has bled from the filter and the water is up to the top of the filter. **CLOSE THE AIR RELIEF BLEED VALVE**.
16. The filter will **BACKWASH**. Water will pump through the laterals to clean the inside of the filter and water will go to waste. The level of the pond may drop at this stage. The first time you do this, observe the water level as you may need to adjust the height of your skimmer plate.
17. Switch the **PUMP OFF**.
18. Turn the multiport valve handle to the **RINSE** position.
19. Switch the **PUMP ON**. The filter will now rinse out.
20. Look at the **SIGHT GLASS** on the multiport valve as the water is going to waste.
21. Once clear water runs through the sight glass, switch the **PUMP OFF**.
22. Turn the multiport valve handle to the **FILTER** position.
23. Switch the **PUMP ON**.
24. **CAREFULLY OPEN THE AIR RELIEF BLEED VALVE** to allow water to rise to the top.
25. **CLOSE THE AIR RELIEF BLEED VALVE**.
26. The filter is now clean and fully operational.
27. Check the water level in the pond and adjust the height of the skimmer plate ready to top up your pond level.

HOW TO GET THE BEST FROM YOUR K+ADVANCED FILTER

The biological side of the filter can take several weeks to fully mature. To speed up this process, add the **PURE+FILTERSTARTGEL** to the filter.

Top tips for optimum biological performance:

- For best results for the prevention of green water use an evoUV pond clarifier. A UV-C is recommended on every pond installation.
- Maintain a stable pond pH of 7 or higher.
- Maintain a pond Nitrate reading of 50mg/l or less.
- Always dechlorinate your mains water. Use an Evolution Aqua Dechlorinator for removal of harmful chlorine when topping up with mains water.
- Add **PURE+FILTERSTARTGEL** to the filter media inside the K+Advanced Filter.

Ask your local EA dealer for advice.

SHUTTING DOWN FOR WINTER

If you live in an area, or have installed the K+Advanced Filter in a position that will experience sub zero temperatures, you may decide to shut your filter down for the Winter. Here is a guide on how to do this:

1. Perform a thorough rinse and backwash of the filter, then move the MPV to the “**CLOSE**” position.
2. Close any in-line valves before and after the K+Advanced Filter .
3. Open the air pressure release valve at the top of the unit.
4. Open the drain plug at the base of the unit. Water will drain from the vessel.
5. Loosen all connections and drain water from valves, pipes, pumps and UVs. Ensure that no water is trapped. Remember water can expand by 10% when it is ice and can cause permanent damage.

STARTING UP IN SPRING

1. Add **PURE+FILTERSTARTGEL** to the K+Advanced Filter .
2. Tighten up all connections that were undone over Winter.
3. Use PTFE tape or silicone around the drain plug if it has been removed to ensure its water tight.
4. Tighten the air pressure release valve.
5. Move the multiport valve to the **FILTER** position and switch pump on. Check for leaks. Your K+Advanced Filter is fully operational.
6. The K+Media will mature quickly. Monitor water readings for the first 2 weeks.

OPENING / CLOSING THE LID



IMPORTANT: Do not overtighten the nuts on the lid, and follow the 12 bolt torque sequence when tightening the nuts to 9Nm to prevent damage.



Remove the 12 plastic caps covering the nuts on the lid collar. You may need to use a flat head screwdriver.



Carefully undo all 12 nuts (M8) using a torque wrench and remove washers. Keep them safe.



Carefully remove the lid.

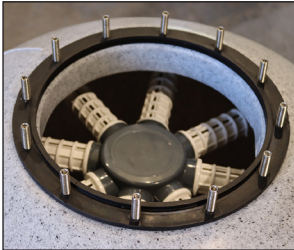

Ensure the large, black O-ring around the lid is in place. Gently push it down before re-fitting the lid.

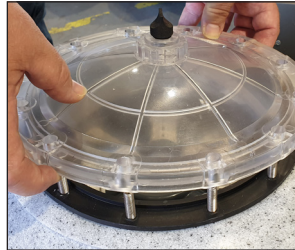

TO RE-INSTALL - Carefully place the lid over the studs.

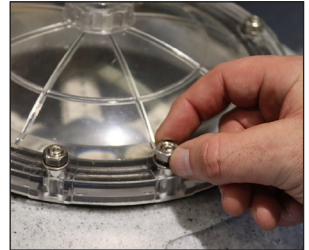

Re-fit all 12 x M8 washers onto studs and the M8 nuts.

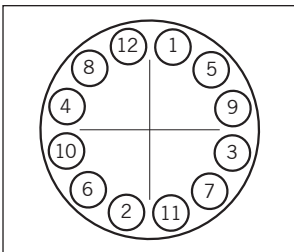

YOU MUST follow the 12 Bolt Torque Pattern sequence when tightening the nuts.

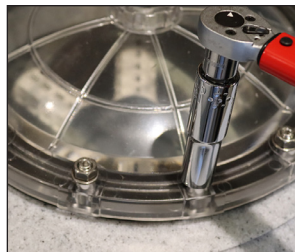

Use a torque wrench pre-set at 9Nm until clicks following the tightening sequence.



Re-fit the 12 plastic caps over the top of the nuts. Ensure the air relief bleed valve is screwed into the lid.

TROUBLE SHOOTING

Pond water is still dirty after backwashing

1. Insufficient filtration time
2. Low flow
3. Dirty filter requires rinsing and backwashing
4. Pump has blocked.
5. Inlet line is blocked.
6. Pump is not primed.
7. Incorrect water chemistry. Check pH and other water readings. Check UV is working correctly (replace UV bulbs older than 6 - 12 months).
8. Clogged or channelled media. Perform an extra long rinse and backwash.

Filter media does not appear to move during cleaning

- Switching the Air Blower ON and OFF 2 or 3 times and performing multiple rinses can free up media.
- Performing a backwash prior to following the cleaning instructions can free up the media.
- Operating the filter on re-circulate will determine if the restriction is in the filter.
- If you don't succeed when following the two points above, switch off the pump, isolate and drain the filter. Manually drain the filter, remove the lid and inspect the inside of the unit. The media may need to be removed and cleaned.

Above normal or excessive force is needed to operate the multi-port valve

Scoring or jamming with foreign matter or debris. If this condition persists after rinsing, disassemble the valve to clear. Continued operation may result in leaking due to damage to the multi-port valve (spider gasket).

Replacement spider gaskets are available. Order codes are EA CODE: SPK1BF26 for 1½" and EA CODE: SPK1BF27 for 2".

GUARANTEE

This product is guaranteed against defects in material and workmanship for 2 years from the date of purchase, under normal usage. The guarantee DOES NOT APPLY in case of improper use, negligence, lack of maintenance or accidental damage to the K+Advanced filter. If the K+Advanced Filter fails due to a manufacturing fault within this period it will be either repaired or replaced free of charge. Liability is limited to replacement of the faulty product only; no other costs will be reimbursed. This guarantee is not transferable and does not affect your statutory rights. This guarantee does not confer any rights other than those expressly set out above.

The manufacturer or supplier shall not be responsible, or held liable for any damages caused by defective components or materials of this product; or for loss incurred by interruption of service; or any consequential/incidental damages and expenses arising from the production, sale use or misuse of this product or any other consequential loss.

Any warranty claim must be accompanied by a valid, dated proof of purchase.

Evolution Aqua and its dealers shall not be held liable for any loss of fish, plants or any other livestock as a result of any failure or defect of this product.

The installation and use of your product outside of our recommendations as printed in this manual may also void the warranty.

REGISTER YOUR WARRANTY ONLINE

The easiest way to register your warranty is to visit our website online at
www.evolutionaqua.com/product-warranty

If you prefer to post your warranty form, complete the details below and send it to:

Evolution Aqua, Kellet Close, Wigan, Lancashire, WN5 0LP

or scan and email it to

marketing@evolutionaqua.com

Evolution Aqua K+Advanced Filter Warranty Form

NAME:

ADDRESS:

POSTCODE:

COUNTRY:

EMAIL:

PRODUCT AND MODEL:

PURCHASED FROM:

DATE OF PURCHASE:

SIGNED:

DATE:

VISIT OUR WEBSITE AND FOLLOW US ON SOCIAL MEDIA



For all the latest Evolution Aqua news sign up to our email newsletter to have the newest info delivered direct to your inbox. Keep up to date by following us on social media, join our Pond Owners Club on Facebook or check out our website for technical information and product advice at www.evolutionaqua.com.



INSTRUCTION MANUALS

Download instruction manuals for all Evolution Aqua products



PARTS STORE

Find spare parts and accessories for Evolution Aqua products



FAQS

Read frequently asked questions about Evolution Aqua products



EMAIL NEWSLETTERS

Sign up to receive our email newsletters at evolutionaqua.com/newsletter



STOCKISTS

Locate your nearest Evolution Aqua product stockist



EA POND OWNERS CLUB

Search Evolution Aqua Pond Owners Club on Facebook to join the community



FACEBOOK

Keep updated with our latest news at facebook.com/evolutionaqua



INSTAGRAM

Follow us on Instagram for updates at instagram.com/evolution_aqua



TIKTOK

Follow us on TikTok at tiktok.com/@evolution_aqua



YOUTUBE

Watch our YouTube channel at youtube.com/evolutionaqualtd

Evolution Aqua Ltd

Kellet Close
Wigan
Lancashire
United Kingdom
WN5 0LP

www.evolutionaqua.com

EVOLUTION
AQUA

INNOVATION IN WATER